

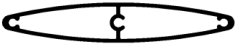

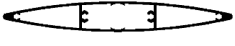

Louvres

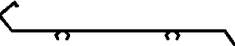

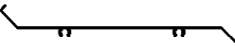
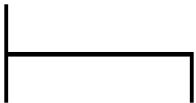

	LOUVRE 88 x 14.75mm							
	Code:	Mass/M	AP	Length	Mill Finish			Pack Size
	ZL-2779	0.791	0.184	6.5	•			4
	LOUVRE 160 x 20mm							
	Code:	Mass/M	AP	Length	Mill Finish			Pack Size
	ZL-5001	1.654	0.326	6.5	•			2
	100MM LOUVRE							
	Code:	Mass/M	AP	Length	Mill Finish			Pack Size
	ZL-4999	0.567	0.302	6.5	•			6
	150MM LOUVRE							
	Code:	Mass/M	AP	Length	Mill Finish			Pack Size
	ZL-5280	0.704	0.351	6.5	•			4
	92MM H COVER CHANNEL							
	Code:	Mass/M	AP	Length	Mill Finish			Pack Size
	ZL-4994	0.683	0.327	6.5	•			4
	87MM ZED COVER SCREEN							
	Code:	Mass/M	AP	Length	Mill Finish			Pack Size
	ZL-4995	0.757	0.285	6.5	•			4
	94mm STEPPED LOUVRE BLADE R5							
	Code:	Mass/M	AP	Length	Mill Finish			Pack Size
	TR-6094	1.033	0.460	6.5	•			2
	94mm STEPPED LOUVRE BLADE CLIP R2							
	Code:	Mass/M	AP	Length	Mill Finish			Pack Size
	TR-6093	0.855	0.311	6.5	•			2
	LOUVRE TOP TRACK							
	Code:	Mass/M	AP	Length	Mill Finish			Pack Size
	ZL-11219	1.109	0.358	6.5	•			2

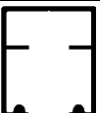
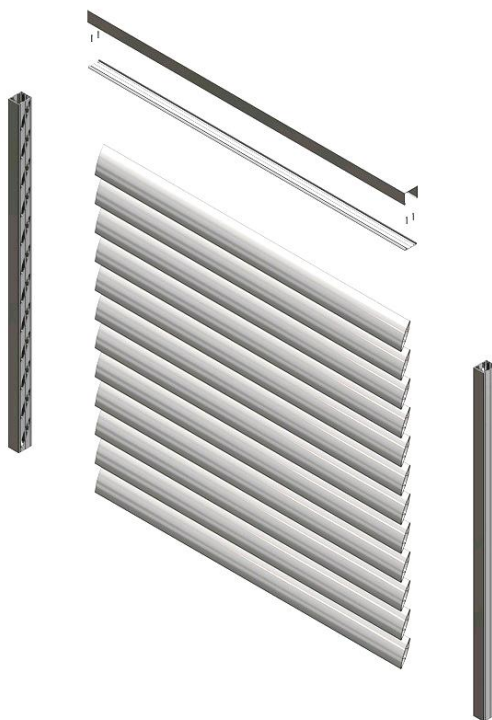
Louvre Systems - Easy Fix Louvre Screen

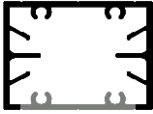
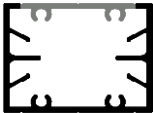
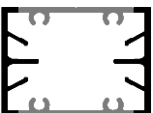

8mm Gap
68° Pitch
1200mm max span

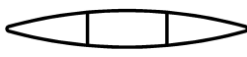
AVAILABLE FINISHES: MILL, MANNEX BLACK TEXTURE, DARK CEDAR WOOD GRAIN









	50x40mm FRAME - LEFT - Machined to except ZL-10209							
	Code:	Mass/M	AP	Length	Mill Finish	Mannex Black	Dark Cedar	Pack Size
	AE814L	1.326	0.180	5.111	•	•	•	
	50x40mm FRAME - RIGHT - Machined to except ZL-10209							
	Code:	Mass/M	AP	Length	Mill Finish	Mannex Black	Dark Cedar	Pack Size
	AE814R	1.326	0.180	5.111	•	•	•	
	50x40mm FRAME - MIDRAIL - Double Machined to except ZL-10209							
	Code:	Mass/M	AP	Length	Mill Finish	Mannex Black	Dark Cedar	Pack Size
	AE814M	1.326	0.180	5.111	•	•	•	
	50x40mm FRAME - PLAIN MIDRAIL - Double Machined ZL-10209 passes through							
	Code:	Mass/M	AP	Length	Mill Finish	Mannex Black	Dark Cedar	Pack Size
	AE1023L	1.035	0.180	5.111	•	•	•	
	92 x 15mm ELLIPTICAL LOUVRE BLADE							
	Code:	Mass/M	AP	Length	Mill Finish	Mannex Black	Dark Cedar	Pack Size
	ZL-10209	0.677	0.190	5	•	•	•	2
	50x40mm CHANNEL - <i>Use top and bottom to make a sliding panel</i>							
	Code:	Mass/M	AP	Length	Mill Finish	Mannex Black	Dark Cedar	Pack Size
	AE834	0.713	0.271	5	•	•	•	
	CHANNEL ADAPTOR - Clips to channel AE834							
	Code:	Mass/M	AP	Length	Mill Finish	Mannex Black	Dark Cedar	Pack Size
	AE835 (LM1)	0.257	0.118	5	•	•	•	

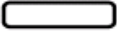

	PLASTIC CAP - Suits AE814 and AE834/AE835 When required (500per box)							
	Code:			Each	Black Plastic			Bag Size
	AE814ENDCAPBL				•			100

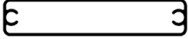
Louvre Systems - Easy Fix Louvre Screen Continued

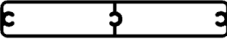
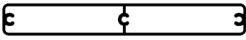
	COOLROOM CHANNEL 53 x 25 x 1.2mm							
	Code:	Mass/M	AP	Length	Mill Finish	Mannex Black	Dark Cedar	Pack Size
	ZL-3020 (LM1)	0.326	0.203	6.5	•	•	•	8

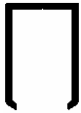
Privacy / Slat Screens



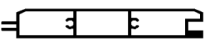
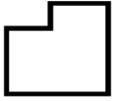

	Rectangular Hollow 40 x 10 x 1.1							
	Code:	Mass/M	AP	Length	Mill Finish			Pack Size
	R401011 (LM1)	0.285	0.1	6.5	•			14
	Rectangular Hollow 50 x 10 x 1.1 ALSO AVAILABLE IN 5.000m							
	Code:	Mass/M	AP	Length	Mill Finish			Pack Size
	R501011 (LM1)	0.339	0.12	6.5	•			10
	Rectangular Hollow 65 x 16 x 1.2							
	Code:	Mass/M	AP	Length	Mill Finish			Pack Size
	R651612	0.498	0.162	6.5	•			6
	Rectangular Hollow 65 x 16 x 1.4 ALSO AVAILABLE IN 5.000m							
	Code:	Mass/M	AP	Length	Mill Finish	Mannex Black	Dark Cedar	Pack Size
	R651614	0.578	0.162	6.5	•	0.00	0.00	8
	Rectangular Hollow 65 x 16 x 1.2 with screw flutes (AE107)							
	Code:	Mass/M	AP	Length	Mill Finish			Pack Size
	R651612F	0.588	0.157	6.5	•			6
	Rectangular Hollow 80 x 16 x 1.2 with screw flutes (AE045)							
	Code:	Mass/M	AP	Length	Mill Finish			Pack Size
	R801612F	0.685	0.187	6.5	•			4
	Rectangular Hollow 90 x 16 x 1.4 - MILL ORDER ONLY							
	Code:	Mass/M	AP	Length	Mill Finish			Pack Size
	R901614 (051466)	0.768	0.207	6.5	•			2
	Rectangular Hollow 100 x 16 x 1.2 with screw flutes (AE058)							
	Code:	Mass/M	AP	Length	Mill Finish			Pack Size
	R1001612F	0.902	0.227	6.5	•			4
	Rectangular Hollow 125 x 16 x 1.2 with screw flutes (AE059)							
	Code:	Mass/M	AP	Length	Mill Finish			Pack Size
	R1251612F	1.065	0.277	6.5	•			4
	HEX SLAT / TOUGHENING BAR (45x25mm)							
	Code:	Mass/M	AP	Length	Mill Finish			Pack Size
	AE771	0.538	0.113	6.5	•			6
	DEEP RECEIVER CHANNEL - RHS 50x10 fits inside							
	Code:	Mass/M	AP	Length	Mill Finish			Pack Size
	ZL-7288 (LM1)	0.230	0.128	4	•			10

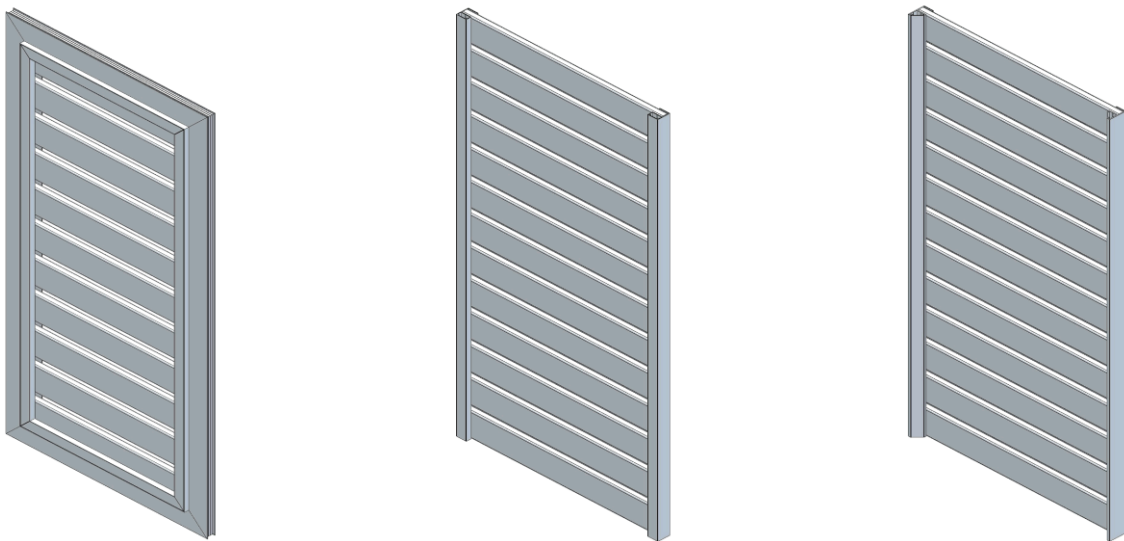

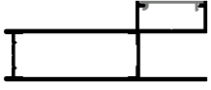
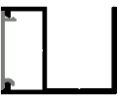

	PRIVACY CHANNEL - 50x25mm							
	Code:	Mass/M	AP	Length	Mill Finish			Pack Size
	ZL-12259	0.588	0.224	6.5	•			6
	PRIVACY CHANNEL INFILL - 53mm - Clips into ZL-12259							
	Code:	Mass/M	AP	Length	Mill Finish			Pack Size
	ZL-12260 (LM1)	0.231	0.121	6.5	•			16
	CHIPLER 106mm-Overall (90mm Visible) x 16mm Wide SLAT - MILL ORDER ONLY							
	Code:	Mass/M	AP	Length	Mill Finish			MOQ
	ZL-7294	1.140	0.272	6.5	•			40
	PRIVACY SURROUND - Suits 65 x 16 and 50 x 10 Picket (1.8 Thick) - MILL ORDER ONLY							
	Code:	Mass/M	AP	Length	Mill Finish			Pack Size
	ZL-5875	0.745	0.160	6.5	•			2

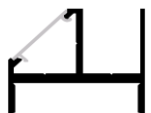
Privacy / Slat Screen Systems



AVAILABLE FINISHES: MILL, MANNEX BLACK TEXTURE, SATIN BLACK, DARK CEDAR WOOD GRAIN, PRECIOUS SILVER
MILL FINISH PRICES NOT SHOWN

	PRIVACY GATE FRAME (Pictured with ZL-9381 clipped in) (Standard STAKEMKK4899)							
	Code:	Mass/M	AP	Length	Satin Black P.Silver	Mannex Black	Dark Cedar	Pack Size
	AE1110	0.823	0.284	6	•	•	•	4
	SLAT SCREEN FRAME SQUARE (Pictured with ZL-9381 clipped in)							
	Code:	Mass/M	AP	Length	Satin Black P.Silver	Mannex Black	Dark Cedar	Pack Size
	AE1111 (LM1)	0.321	0.185	5	•	•	•	12
	SLAT SCREEN FRAME BEVELLED (Pictured with ZL-9381 clipped in)							
	Code:	Mass/M	AP	Length	Satin Black P.Silver	Mannex Black	Dark Cedar	Pack Size
	AE1112	0.452	0.190	5	•	•	•	8
	SLAT SCREEN FRAME OLD (Pictured with ZL-9381 clipped in) - OLD DESIGN							
	Code:	Mass/M	AP	Length		Mannex Black	Dark Cedar	Pack Size
	ZL-9461	0.665	0.234	5		•	•	6
	SLAT SCREEN INFILL							
	Code:	Mass/M	AP	Length	Satin Black P.Silver	Mannex Black	Dark Cedar	Pack Size
	ZL-9381 (LM2)	0.075	0.100	5	•	•	•	52

	SLAT BRACE - 25x12mm							
	Code:	Mass/M	AP	Length	Satin Black P.Silver	Mannex Black	Dark Cedar	Pack Size
	GYCK040 (LM2)	0.167	0.103	5	•	•	•	22
	Rectangular Hollow 65 x 16 x 1.4							
	Code:	Mass/M	AP	Length	Satin Black P.Silver	Mannex Black	Dark Cedar	Pack Size
	R651614	0.578	0.162	6.5	•	•	•	8
	Angle 40 x 20 x 1.6							
	Code:	Mass/M	AP	Length	P/Coat	Mannex Black	Dark Cedar	Pack Size
	A402016 (LM1)	0.253	0.120	6.5	•	•	•	10
	Plastic Infill Cap for New Square and Bevelled frames - COMING SOON!							
	Code:			Each	Black Plastic			Pack Size
	50mm PLAIN POST - PERFECT TO FIX TO, COMBINE WITH 100mm BASE PLATE							
	Code:	Mass/M	AP	Length	Satin Black P.Silver	Mannex Black	Dark Cedar	Pack Size
	AE413	1.067	0.198	5.7	•	•	•	2

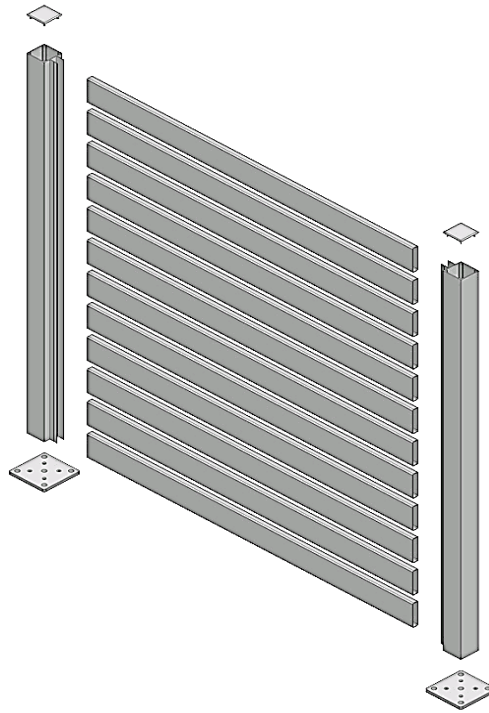

Privacy / Slat Screen Systems - CONTINUED

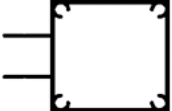

AE895 Shown Here
Optional Hand Rail - AE897/AE898

AVAILABLE FINISHES: MILL, SATIN BLACK, PRECIOUS SILVER, DARK CEDAR

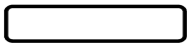
	50mm 1 WAY PRIVACY POST							
	Code:	Mass/M	AP	Length	Mill Finish	P/Coat Price	Dark Cedar	Pack Size
	AE895	1.240	0.278	5.7	•	•	•	2

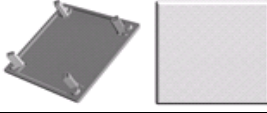
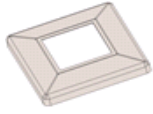
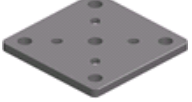
	50mm 2 Way PRIVACY POST							
	Code:	Mass/M	AP	Length	Mill Finish	P/Coat Price	Dark Cedar	Pack Size
	AE896	1.412	0.358	5.7	•	•	•	1
	Rectangular Hollow 65 x 16 x 1.4							
	Code:	Mass/M	AP	Length	Mill Finish	P/Coat Price	Dark Cedar	Pack Size
	R651614	0.578	0.162	6.5	•	•	•	8
	Channel 20x20x1.6mm - Attach for Corner or 3 Way Configuration (020230)							
	Code:	Mass/M	AP	Length		P/Coat Price	Dark Cedar	Pack Size
	C202016 (LM1)	0.246	0.117	5.7		•	•	1
	CAST ALUMINIUM POST TOP CAP for AE413 and 50mm Glazed POSTS - FLAT							
	Code:			Each	Mill Finish	P/Coat Price		Pack Size
	PTCF50	0.016			•	•		#REF!
	PRESSED ALUMINIUM COVER PLATE - Notched out by customer							
	Code:			Each	Mill Finish	P/Coat Price		Pack Size
	CP100	0.034			•	•		#REF!
	ALUMINIUM SCREW ON BASE PLATE for - SLAT POSTS, PLAIN POST, GLAZED POSTS							
	Code:			Each	Mill Finish	P/Coat Price		Pack Size
	BP100	0.197			•	•		#REF!